

ULTRADYN PRODUCTS SPECIFICATION

- HOLLOW FIBER UF MEMBRANE MODULE -

FB02-FC-FUS5082

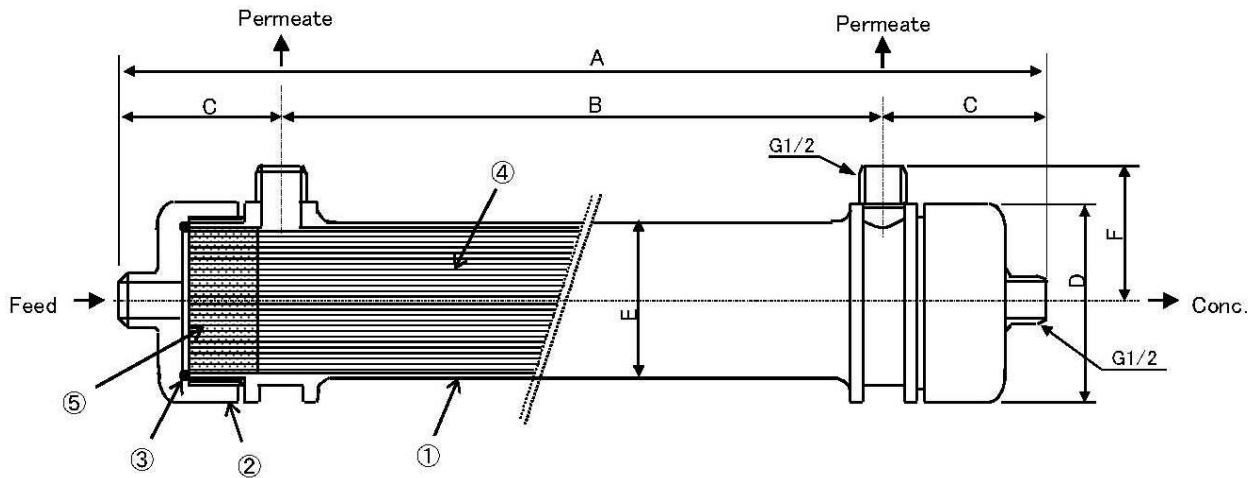

Module

	A	B	C	D	E	F
Dimension mm	356	250	53	Ø 60	Ø 45	42

Module components

Article	Name	Material	Num.
①	Case	Polysulfone	1
②	Cap	Polysulfone	2
③	O-Ring type AS568-239	FPM	2
④	Hollow fiber	Polyethersulfone	-
⑤	Potting resin	Epoxy resin	-

FPM: Fluoro Rubber

Standard configurations

Filtration type	Ultrafiltration	
Membrane material	Polyethersulfone	
Molecular cutoff	500,000	Dalton
Hollow fiber inner diameter	0.8	mm
Membrane area	0.25	m ²
Standard water flux ⁽¹⁾	390	l/h
Shipping water flux range ⁽¹⁾	271	l/h
Feed inlet pressure, max. ⁽³⁾	0.4	MPa
Transmembrane pressure, max.	0.3	MPa
Temperature, max.	98	°C
Applicable pH range	1 ~ 13	
Standard inlet feed flow ⁽²⁾	690	l/h
Weight at operation	0.9	kg
Weight at shipping	0.4	kg
Standard preservative	1000 ppm Benzoic acid	
Connectors	Feed/Conc.:	G1/2
	Permeate:	G1/2

⁽¹⁾ Initial water flux by dead end filtration with pure water under T.M.P. 0.1 MPa at 25°C

⁽²⁾ Standard condition is adjusted to 1 m/sec feed velocity. Please notice that the optimum velocity is different for each application.

⁽³⁾ This value is for room temperature.

DAICEN Membrane Systems Ltd. is the manufacturer of the ULTRADYN modules and markets and distributes them under the registered trademark MOLSEP®.

MICRODYN-NADIR behält sich das Recht vor, Angaben ohne vorherige Ankündigung anzupassen.
We reserve the right to change specifications without prior notification.

MICRODYN-NADIR GmbH
Industriepark Kalle-Albert
Kasteler Straße 45
D-65203 Wiesbaden

Telefon: +49 (0) 611/962-6001
Telefax: +49 (0) 611/962-9237
E-Mail: info@microdyn-nadir.de
Internet: www.microdyn-nadir.de

